

# Data Sheet



Article number: 021300705028

Description: Sealing Clamp S 28 W5

## Measures

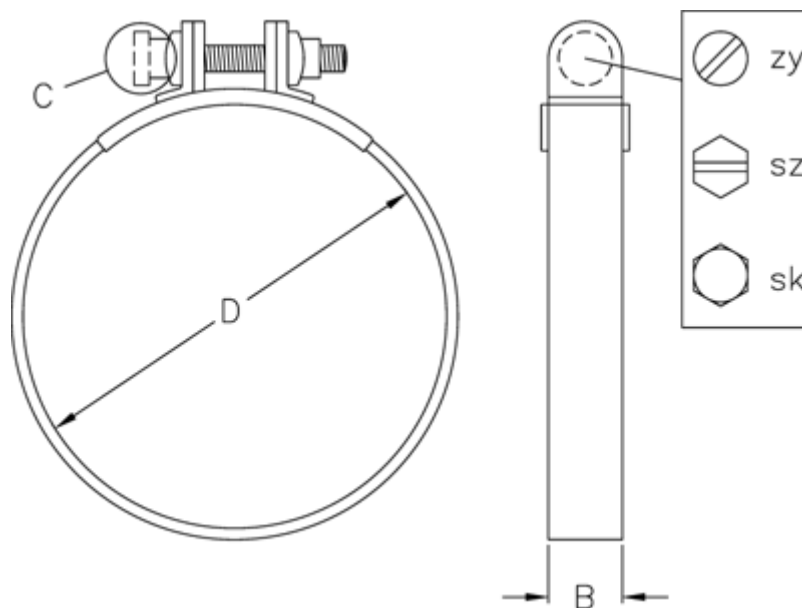

C (screw type) = SZ

Diameter D = 28

Width B = 12